

DATA SHEET

For a complete data sheet, please also download:

- The IC04 LOCMOS HE4000B Logic Family Specifications HEF, HEC
- The IC04 LOCMOS HE4000B Logic Package Outlines/Information HEF, HEC

HEF4528B

MSI

Dual monostable multivibrator

Product specification
File under Integrated Circuits, IC04

January 1995

Dual monostable multivibrator

HEF4528B MSI

DESCRIPTION

The HEF4528B is a dual retriggerable-resettable monostable multivibrator. Each multivibrator has an active LOW input (\bar{I}_0), and active HIGH input (I_1), an active LOW clear direct input (\bar{C}_D), an output (O) and its complement (\bar{O}), and two pins for connecting the external timing components ($C_{TC}^{(1)}$, R_{TC}).

An external timing capacitor (C_t) must be connected between C_{TC} and R_{TC} and an external resistor (R_t) must be connected between R_{TC} and V_{DD} . The duration of the

output pulse is determined by the external timing components C_t and R_t .

A HIGH to LOW transition on \bar{I}_0 when I_1 is LOW or a LOW to HIGH transition on I_1 when \bar{I}_0 is HIGH produces a positive pulse (LOW-HIGH-LOW) and O and a negative pulse (HIGH-LOW-HIGH) on \bar{O} if the \bar{C}_D is HIGH. A LOW

(1) Always connected to ground.

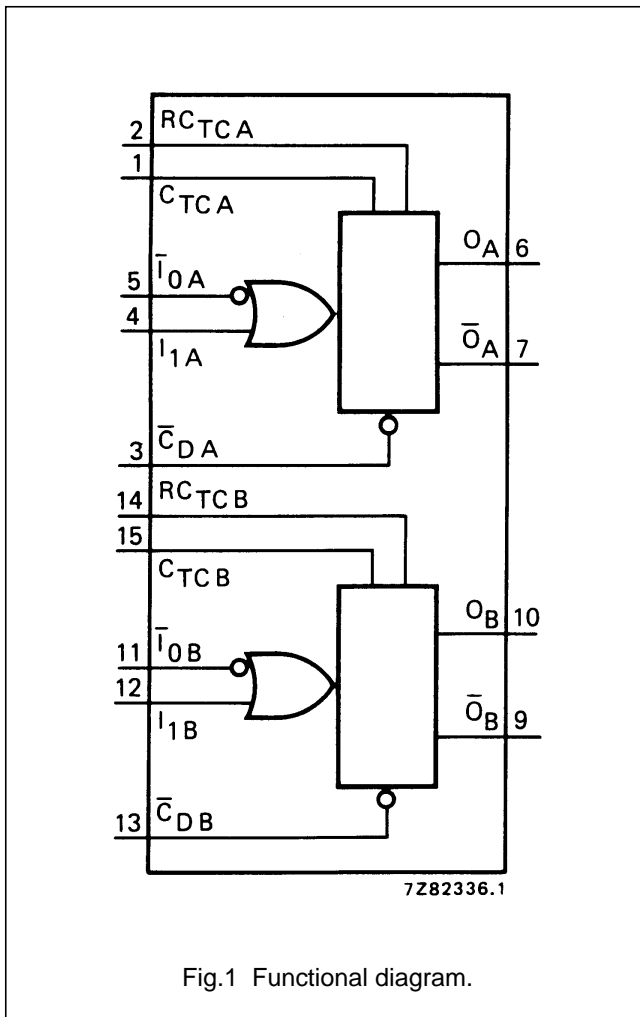

Fig.1 Functional diagram.

on \bar{C}_D forces O LOW, O HIGH and inhibits any further pulses until \bar{C}_D is HIGH.

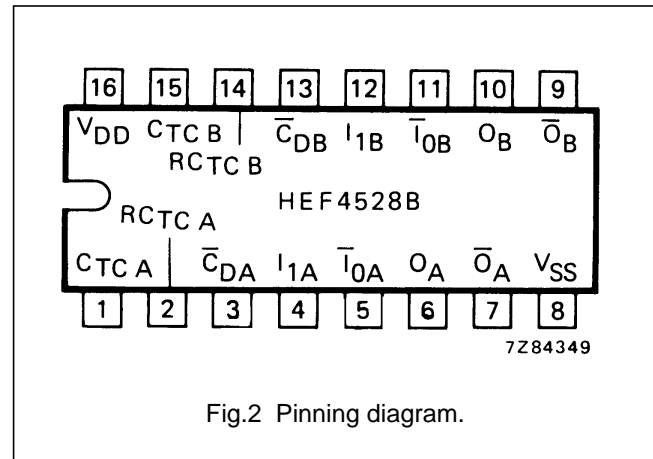

Fig.2 Pinning diagram.

- HEF4528BP(N): 16-lead DIL; plastic (SOT38-1)
- HEF4528BD(F): 16-lead DIL; ceramic (cerdip) (SOT74)
- HEF4528BT(D): 16-lead SO; plastic (SOT109-1)
- (): Package Designator North America

PINNING

- $\bar{I}_{0A}, \bar{I}_{0B}$ input (HIGH to LOW triggered)
- I_{1A}, I_{1B} input (LOW to HIGH triggered)
- $\bar{C}_{DA}, \bar{C}_{DB}$ clear direct input (active LOW)
- O_A, O_B output
- \bar{O}_A, \bar{O}_B complementary output (active LOW)
- $C_{TC A}, C_{TC B}$ external capacitor connections ⁽¹⁾
- $R_{TC A}, R_{TC B}$ external capacitor/ resistor connections

FAMILY DATA, I_{DD} LIMITS category MSI

See Family Specifications

Dual monostable multivibrator

HEF4528B
MSI

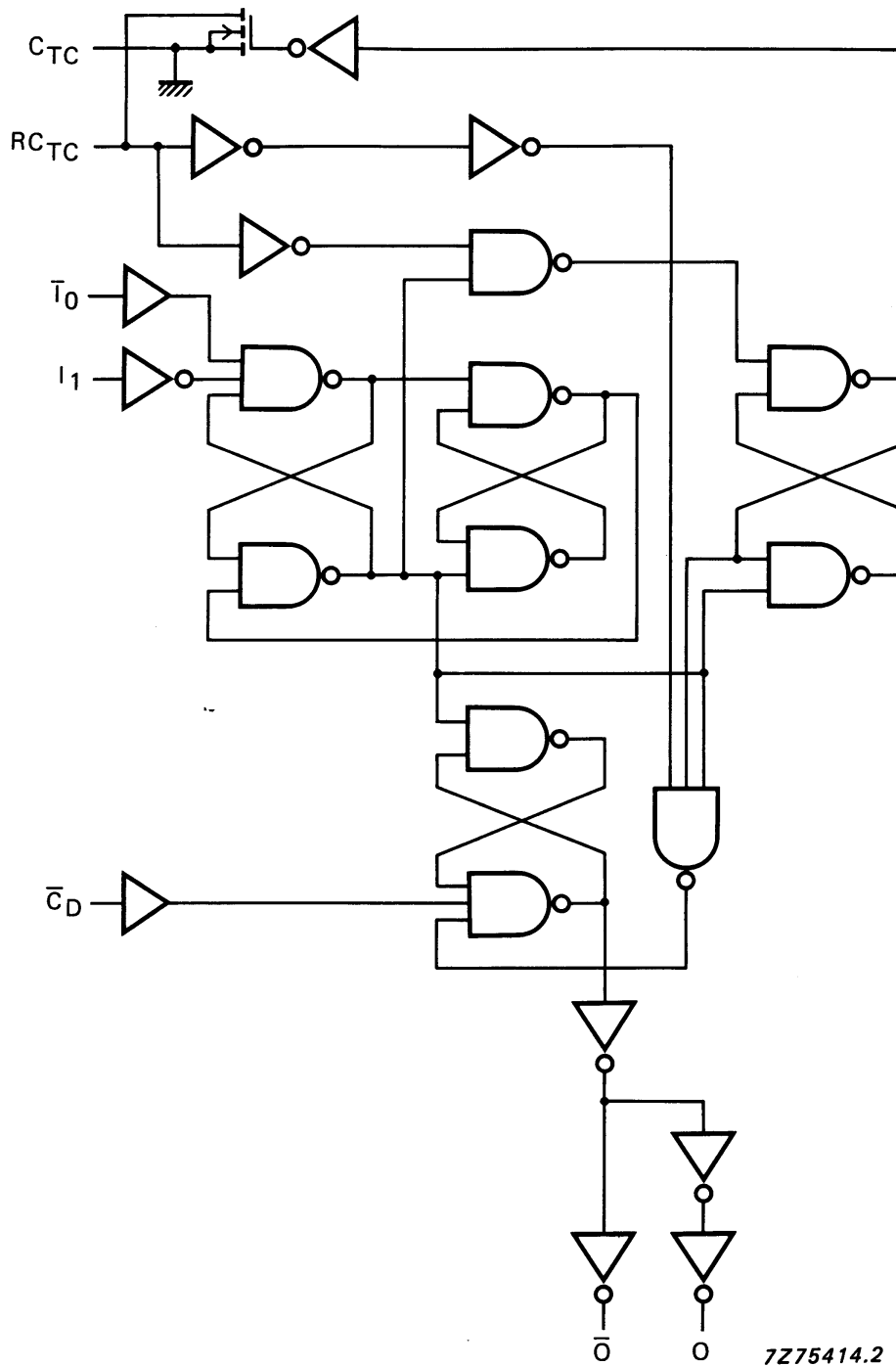







Fig.3 Logic diagram (one monostable multivibrator).





Dual monostable multivibrator

HEF4528B
MSI

FUNCTION TABLE

INPUTS			OUTPUTS	
\bar{I}_0	I_1	\bar{C}_D	O	\bar{O}
	L	H		
H		H		
X	X	L	L	H

Notes

1. H = HIGH state (the more positive voltage)
2. L = LOW state (the less positive voltage)
3. X = state is immaterial
4.  = positive-going transition
5.  = negative-going transition
6.   = positive or negative output pulse; width is determined by C_t and R_t

AC CHARACTERISTICS

 $V_{SS} = 0$ V; $T_{amb} = 25$ °C; $C_L = 50$ pF; input transition times ≤ 20 ns

	V_{DD} V	SYMBOL	MIN.	TYP.	MAX.	TYPICAL EXTRAPOLATION FORMULA	
Propagation delays $\bar{I}_0, I_1 \rightarrow \bar{O}$ HIGH to LOW $\bar{I}_0, I_1 \rightarrow O$ LOW to HIGH $\bar{C}_D \rightarrow O$ HIGH to LOW $\bar{C}_D \rightarrow \bar{O}$ LOW to HIGH	5			140	280	ns	113 ns + (0,55 ns/pF) C_L
	10	t_{PHL}		50	100	ns	39 ns + (0,23 ns/pF) C_L
	15			35	70	ns	27 ns + (0,16 ns/pF) C_L
	5			155	305	ns	128 ns + (0,55 ns/pF) C_L
	10	t_{PLH}		60	115	ns	49 ns + (0,23 ns/pF) C_L
	15			40	80	ns	32 ns + (0,16 ns/pF) C_L
	5			105	210	ns	78 ns + (0,55 ns/pF) C_L
	10	t_{PHL}		40	85	ns	29 ns + (0,23 ns/pF) C_L
	15			30	60	ns	22 ns + (0,16 ns/pF) C_L
Output transition times HIGH to LOW LOW to HIGH	5			60	120	ns	10 ns + (1,0 ns/pF) C_L
	10	t_{THL}		30	60	ns	9 ns + (0,42 ns/pF) C_L
	15			20	40	ns	6 ns + (0,28 ns/pF) C_L
	5			60	120	ns	10 ns + (1,0 ns/pF) C_L
	10	t_{TLH}		30	60	ns	9 ns + (0,42 ns/pF) C_L
	15			20	40	ns	6 ns + (0,28 ns/pF) C_L

Dual monostable multivibrator

HEF4528B
MSI

AC CHARACTERISTICS

 $V_{SS} = 0\text{ V}$; $T_{amb} = 25\text{ °C}$; input transition times $\leq 20\text{ ns}$; $R_t = 5\text{ k}\Omega$; $C_t = 15\text{ pF}$

	V_{DD} V	TYPICAL FORMULA FOR P (μW)	
Dynamic power	5	$4000 f_i + \sum (f_o C_L) \times V_{DD}^2$	where f_i = input freq. (MHz) f_o = output freq. (MHz) C_L = load capacitance (pF) $\sum (f_o C_L)$ = sum of outputs V_{DD} = supply voltage (V)
dissipation per	10	$20\,000 f_i + \sum (f_o C_L) \times V_{DD}^2$	
package (P)	15	$59\,000 f_i + \sum (f_o C_L) \times V_{DD}^2$	

AC CHARACTERISTICS

 $V_{SS} = 0\text{ V}$; $T_{amb} = 25\text{ °C}$; $C_L = 50\text{ pF}$; input transition times $\leq 20\text{ ns}$; see also waveforms Fig.5.

	V_{DD} V	SYMBOL	MIN.	TYP.	MAX.	
Recovery time for \bar{C}_D	5	t_{RCD}	0	-75	ns	to avoid change in output
	10		0	-30	ns	
	15		0	-25	ns	
Minimum \bar{I}_0 pulse width; LOW	5	t_{WI0L}	50	25	ns	
	10		30	15	ns	
	15		20	10	ns	
Minimum I_1 pulse width; HIGH	5	t_{WI1H}	50	25	ns	
	10		30	15	ns	
	15		20	10	ns	
Minimum \bar{C}_D pulse width; LOW	5	t_{WCDL}	60	30	ns	
	10		35	15	ns	
	15		25	10	ns	
Set-up time $\bar{C}_D \rightarrow \bar{I}_0$ or I_1	5	t_{su}	0	-105	ns	
	10		0	-40	ns	
	15		0	-25	ns	
Output O pulse width; HIGH	5	t_{WOH}	-	235	ns	note 1
	10		-	155	ns	
	15		-	140	ns	
Output O pulse width; HIGH	5	t_{WOH}	-	5,45	μs	note 2
	10		-	4,95	μs	
	15		-	4,85	μs	
Change in output O pulse width over temperature	5	Δt_{WO}	-	± 3	%	note 3
	10		-	± 2	%	
	15		-	± 2	%	
Change in output O pulse width over V_{DD}	5	Δt_{WO}	-	± 2	%	$V_{DD} \pm 5\%$
	10		-	± 1	%	
	15		-	± 1	%	

Dual monostable multivibrator

HEF4528B
MSI

	V _{DD} V	SYMBOL	MIN.	TYP.	MAX.	
External timing resistor	5	R _t	5	–	2000	kΩ
	10		5	–	2000	kΩ
	15		5	–	2000	kΩ
External timing capacitor	5	C _t	no limits			
	10		no limits			
	15		no limits			

Notes

- R_t = 5 kΩ; C_t = 15 pF; for other R_t, C_t combinations and C_t < 0,01 μF see graph Fig.4.
- R_t = 10 kΩ; C_t = 1000 pF; for other R_t, C_t combinations and C_t > 0,01 μF use formula $t_{WO} = K \cdot R_t \cdot C_t$.
 where: t_{WO} = output pulse width (s)
 R_t = external timing resistor (Ω)
 C_t = external timing capacitor (F)
 K = 0,42 for V_{DD} = 5 V
 K = 0,32 for V_{DD} = 10 V
 K = 0,30 for V_{DD} = 15 V
- T_{amb} = –40 to +85 °C; Δt_{WO} is referenced to t_{WO} at T_{amb} = 25 °C.

Dual monostable multivibrator

HEF4528B
MSI

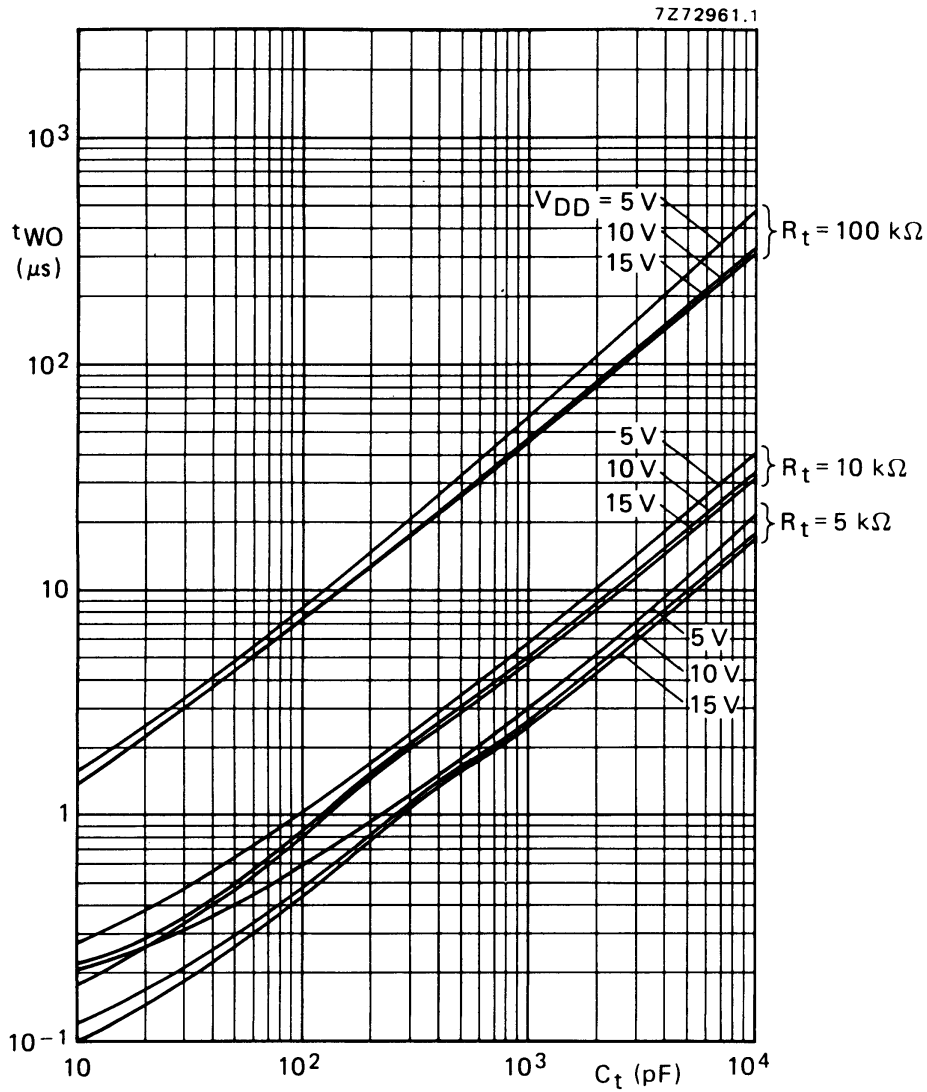

Fig.4 Output pulse width (t_{WO}) as a function of external timing capacitor (C_t).

Dual monostable multivibrator

HEF4528B
MSI

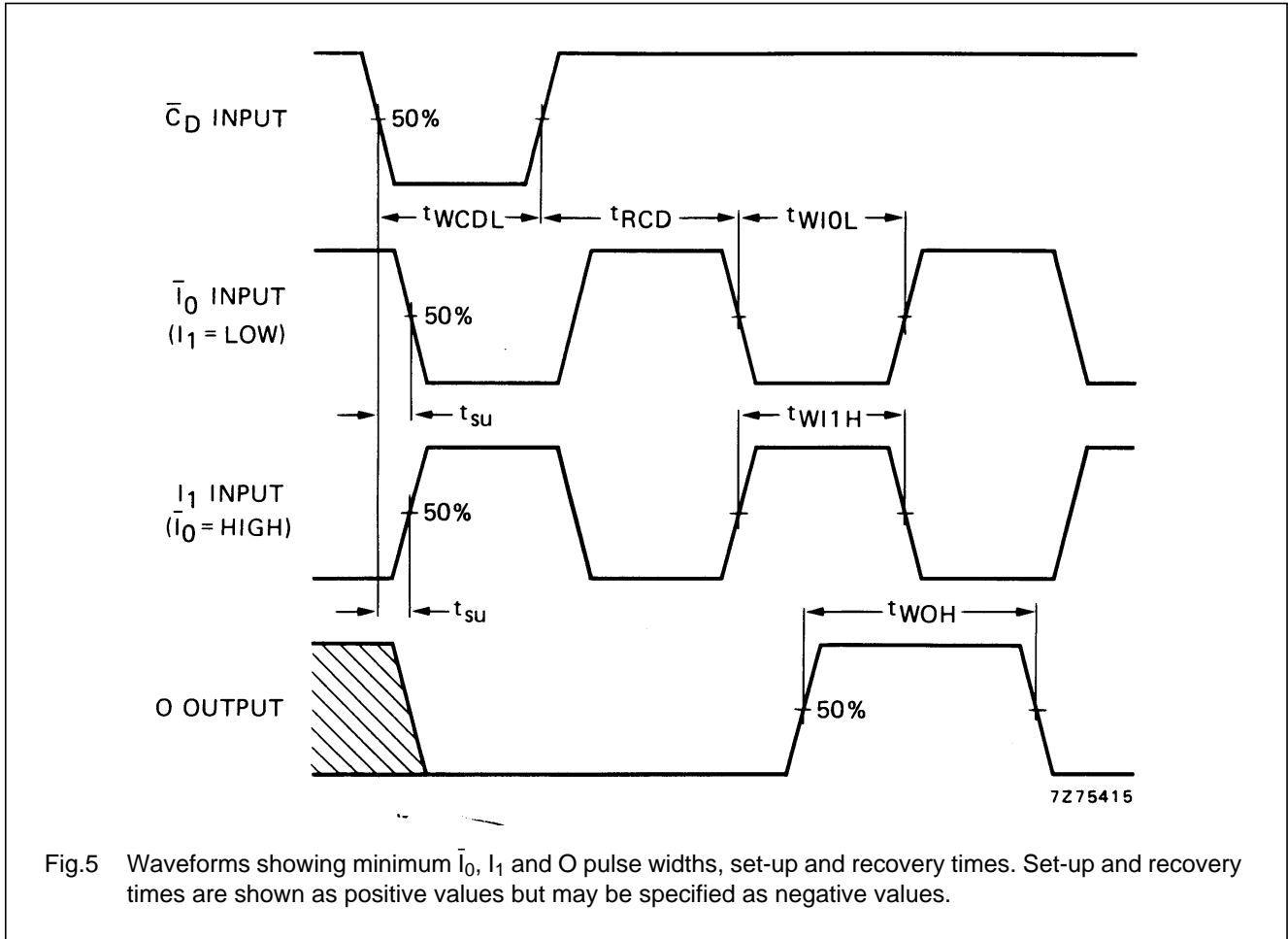

Fig.5 Waveforms showing minimum \bar{I}_0 , I_1 and O pulse widths, set-up and recovery times. Set-up and recovery times are shown as positive values but may be specified as negative values.

APPLICATION INFORMATION

An example of an application for the HEF4528B is:

- Non-retriggerable monostable multivibrator

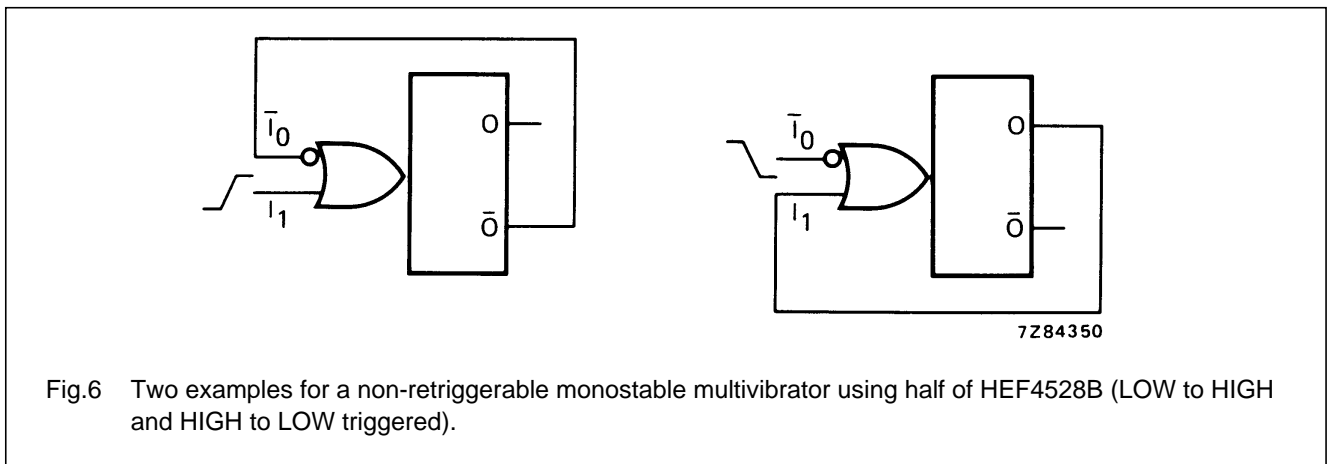

Fig.6 Two examples for a non-retriggerable monostable multivibrator using half of HEF4528B (LOW to HIGH and HIGH to LOW triggered).